

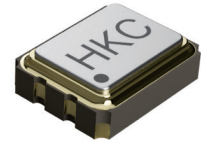

7050 Crystal Clock Oscillator

7050XO Series (LVDS)

Model C4 6 PADS 7.0 x 5.0

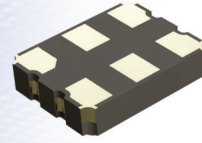

Frequency Range : 25.00MHz to 200.00MHz

Features :

- High reliability & low cost unit
- Tight stability & extended temperature available
- Lead-free type
- For automotive applications, please contact our sales representatives

QUARTZ
CRYSTALS

Standard Specifications

Item	Value
Frequency Range	25.00MHz to 200.00MHz
Frequency Stability	±20ppm, ±50ppm, ±100ppm (or specify)
Operating Temperature Range	-20°C to +70°C, -40°C to +85°C, -40°C to +125°C
Storage Temperature Range	-40°C to +130°C
Operating Voltage	1.8V / 2.5V / 3.3V ±10%
Output Type	LVDS
Current Consumption (Max)	40mA
Output Load	100Ohm (OUT-OUTN differential)
Output Symmetry	45~55%
Output Voltage Level	VOL : $V_{DD}-1.620Max$ / VOH : $V_{DD}-1.025Min$
Phase Jitter RMS (12kHz~20MHz)	0.3ps Max.
Rise and Fall Time	1ns Max. @ 20%~80% Output Level
Tri-State	Yes

Note :
 1. Manufacturer reserves the right to change the specification and content of this product for improvement without notification.
 2. Custom specification is welcome. Please contact our sales representative for further details.
 3. If the crystal is intended for applications which have direct impact on human life and properties, and require a high degree of reliability and safety concerns, customers must provide full information such as but not limit to the application, electrical and reliability specification at the inquiry beginning stage.
 4. Customers have to agree to the "Guideline for handling crystal units" and "Standard Terms and Condition of Sales" which is printed this catalog before placing orders to our company or our distributors. There are also unpredictable factors such as applied condition, oscillation margin and etc and customers must check them beforehand. In case of queries, please do not fail to send inquiry to our company before ordering.

Test Circuit and Dimension

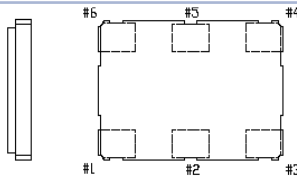
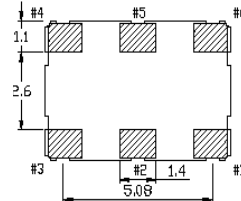
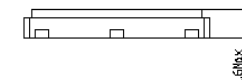
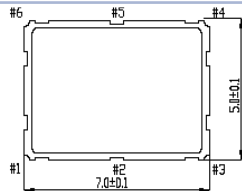
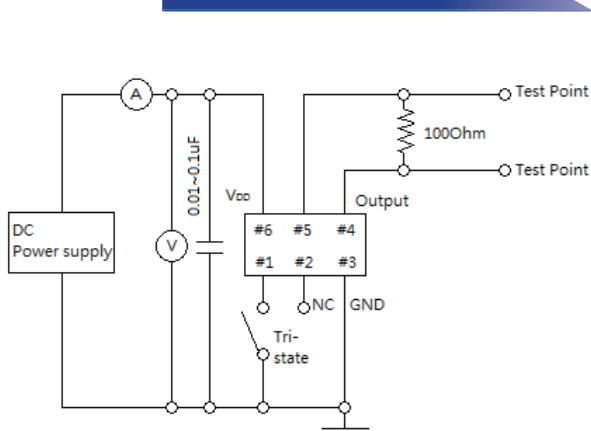

Soldering Pattern

- 1 - Enable Control
- 2 - NC
- 3 - GND
- 4 - OUT
- 5 - ~OUT
- 6 - VDD

